

From clay. From concrete. From experience.

NELSKAMP

Twin trough gutter tile D 15 Ü



The twin trough gutter tile D 15 Ü. (variable)

A former classic on agricultural buildings, the twin trough gutter tile D 15 Ü has also won its place in the authentic modernisation of old buildings. Individual building plans are ideally complemented by the D 15 Ü. In simple or pattern roof cladding.

The D 15 Ü in detail:

- Pressed roof tile according to DIN/EN 1304
- Twin head and side trough
- Waterproof, frost-resistant, breathable
- Regular roof pitch 30°
- Requirement per m² approx. 14.1 pcs



The Colours.



(115) natural red



(116) red engobed



(118) brown engobed



(119) old colours engobed



(121) rustic red engobed



(142) copper red engobed



(144) steamed

Colour deviations: Our clay roof tiles are environment-friendly building materials. When using natural raw materials you may experience colour deviations. This is often the case with naturally red tiles since the fired colour is the sole result of natural raw materials with no added metal oxides to change the colour. Deviations are possible in the colours for reasons of printing methods.

Clay roof tile surfaces: Minor impairments to the surface are possible due to transport. This does not affect the quality of the tiles.

The program.

Moulded bricks for various functions meet the demand for homogeneous, architecturally demanding roofs. They are also an important safety factor. Moulded bricks and accessories reduce the amount of laying work and

facilitate calculations. You will find the complete program for every tile on our Internet website www.nelskamp.de.

	Whole tile Length: ~ 42.0 cm Width: ~ 25.2 cm Weight: ~ 3.1 kg	Covering length: ~ 34.4 cm ± 8 mm Covering width: ~ 20.7 cm Requirement: ~ 14.1 pcs/m ²
--	--	--

	Half tile Length: ~ 42.0 cm Width: ~ 15.0 cm Weight: ~ 2.0 kg	Covering length: ~ 34.4 cm ± 8 mm Covering width: ~ 10.0 cm Requirement: individual
--	---	---

	Left verge tile Length: ~ 42.0 cm Width: ~ 25.0 cm Weight: ~ 4.5 kg	Covering length: ~ 34.4 cm ± 8 mm Covering width: ~ 16.5 cm Requirement: ~ 3.0 pcs/m
--	---	--

	Right verge tile Length: ~ 42.0 cm Width: ~ 25.0 cm Weight: ~ 4.5 kg	Covering length: ~ 34.4 cm ± 8 mm Covering width: ~ 12.5 cm Requirement: ~ 3.0 pcs/m
--	--	--

	Verge tile with outer web on left Length: ~ 42.0 cm Width: ~ 24.3 cm	Covering length: ~ 34.4 cm ± 8 mm Covering width: ~ 21.0 cm
--	---	--

	Verge tile with outer web on right Length: ~ 42.0 cm Width: ~ 25.1 cm	Covering length: ~ 34.4 cm ± 8 mm Covering width: ~ 16.8 cm
--	--	--

	Clover leaf ridge tile ~ 2.7 pcs/m Length: ~ 42.5 cm Width: ~ 28.0 cm Weight: ~ 2.9 kg	Covering length: ~ 37.0 cm Covering width: ~ 20.0 cm Requirement: ~ 2.7 pcs/m
---	--	---

	Start ridge with offset end web for verge tile with offset ridge Length: ~ 42.0 cm Weight: ~ 3.9 kg	Covering length: ~ 34.5 cm Requirement: individual
--	--	---

	Ridge end with offset end web for verge tile with offset ridge Length: ~ 42.0 cm Weight: ~ 4.1 kg	Covering length: ~ 33.0 cm Requirement: individual
--	--	---

	Start ridge with extended web for verge tile with outer web Length: ~ 42.0 cm Weight: ~ 3.9 kg	Covering length: ~ 34.5 cm Requirement: individual
--	---	---

	Ridge end with extended web for verge tile with outer web Length: ~ 42.0 cm Weight: ~ 4.1 kg	Covering length: ~ 33.0 cm Requirement: individual
--	---	---

	Crest initial tile Length: ~ 42.0 cm Weight: ~ 3.5 kg	Covering length: ~ 36.0 cm Requirement: individual
--	--	---

	Hip cap start and end (also available with four outlets) Requirement: individual	
--	--	--

	Clay dormer ventilator (ventilation cross-section ~ 15 cm²) Length: ~ 42.0 cm Width: ~ 25.2 cm Weight: ~ 3.1 kg	Covering length: ~ 34.4 cm ± 8 mm Covering width: ~ 20.7 cm Requirement: individual
--	--	---

	Shed roof tile (left/right verge tiles also available) Length: individual Width: ~ 25.2 cm	Covering length: individual Covering width: ~ 20.7 cm
--	---	--

	Ceramic aerial tile Length: ~ 42.0 cm Width: ~ 25.2 cm Weight: ~ 4.3 kg	Covering length: ~ 34.4 cm ± 8 mm Covering width: ~ 20.7 cm Requirement: individual
--	---	---

	PVC thermal exhaust gas through tile ø 100/125 (can be used up a max of 42° RP*) Length: ~ 42.0 cm Width: ~ 25.2 cm	Covering length: ~ 34.4 cm ± 8 mm Covering width: ~ 20.7 cm
--	--	--

	Light tile „Acrylic glass“ Length: ~ 42.0 cm Width: ~ 25.2 cm	Covering length: ~ 34.4 cm ± 8 mm Covering width: ~ 20.7 cm Requirement: individual
--	--	---

	Ceramic vent pipe tile with weather cap ø 125 and hose with adapter Length: ~ 42.0 cm Width: ~ 25.2 cm	Covering length: ~ 34.4 cm ± 8 mm Covering width: ~ 20.7 cm Requirement: individual
---	---	---

	Walking grid tile PVC x 2 + walking grid Width: ~ 34.0 cm Length: 40.0; 80.0; 150.0 cm	
---	---	--

	SnapStep universal alu step (40 cm and 80 cm universal walking grid with two brackets also available) coated, for mounting on different lath thicknesses, can be adjusted for roof pitches from 0° - 60°	
---	--	--

	Safety step tile, PVC Length: ~ 42.0 cm Width: ~ 25.2 cm Weight: ~ 3.6 kg	Covering length: ~ 34.4 cm ± 8 mm Covering width: ~ 20.7 cm Requirement: individual
---	---	---

	Snow stop tile with round wood holder PVC (also available with PVC snow rib support) Length: ~ 42.0 cm Width: ~ 25.2 cm	Covering length: ~ 34.4 cm ± 8 mm Covering width: ~ 20.7 cm
---	--	--

	PVC solar through tile Length: ~ 42.0 cm Width: ~ 25.2 cm Weight: ~ 0.7 kg	Covering length: ~ 34.4 cm ± 8 mm Covering width: ~ 20.7 cm ø: 30/50/70 mm
--	--	--

	PVC solar carrier tile Length: ~ 42.0 cm Width: ~ 25.2 cm Weight: ~ 2.4 kg	Covering length: ~ 34.4 cm ± 8 mm Covering width: ~ 20.7 cm Requirement: individual
---	--	---

	Plastic skylight, 6-tiles, acrylic glazed Length: ~ 75.0 cm Width: ~ 65.0 cm	Hatch: 47.5 x 52.0 cm Weight: ~ 5.0 kg
---	---	---

	Steel skylight, coated, 6-tiles, acrylic glazed Length: ~ 78.0 cm Width: ~ 64.0 cm	Hatch: 45.0 x 55.0 cm Weight: ~ 8.6 kg
---	---	---

	Steel skylight, coated, 9-tiles, acrylic glazed Length: ~ 110.0 cm Width: ~ 64.0 cm	Hatch: 45.0 x 85.0 cm Weight: ~ 11.0 kg
---	--	--

	Multitherm skylight Length: ~ 85.0 cm Width: ~ 78.0 cm Weight: ~ 15.0 kg	Opening: upwards + to the side Hatch: 44.0 x 54.0 cm Double glazing: ESG Kv 1.4
---	--	---

	Living room skylight wra Length: ~ 98.0 cm Width: ~ 54.0 cm	Opening: to the side Hatch: 46.0 x 90.0 cm Double glazing: ESG Kv 1.1
---	--	---

	Eaves fresh air element ~ 1.1 pcs/m	
---	---	--

	Ridge/crest lath holder	
---	--------------------------------	--

	Ridge or crest clip no. 470/121	
---	--	--

	Copper roll/Alu roll 2000 Length: ~ 5 m Width: ~ 29 cm, 33 cm, 36 cm	Ventilation cross-section: permanent acc. to DIN 4108, Part 3 Natural copper/anthracite, red
---	---	---

	Storm clip no. 435/001 for laths 30 x 50 V2A (1) Storm clip no. 435/002 for laths 40 x 60 V2A (1) Storm clip no. 409/002 V2A (2)	
---	---	--

Laying the twin trough gutter tile D 15 Ü.

Type of laying: Row roofing or pattern roof cladding

Technical data

Roof tile	Twin trough gutter tile D 15 Ü
Manufacturer	Nelskamp (D)
Overall length	~ 42.0 cm
Overall width	~ 25.2 cm
Covering length	~ 34.4 cm ± 8 mm
Mean covering width	~ 20.7 cm
Requirement per m ²	~ 14.1 pieces
Weight per tile	~ 3.1 kg
Weight per m ²	~ 43.7 kg
Regular roof pitch	30°
Laths	30 x 50 mm
Recommended storm clip	435/001
Laths	40 x 60 mm
Recommended storm clip	435/002

Material requirements for coverage

Laths	~ 3.3 m/m ² (incl. 10% waste)
Counter-laths	~ 1.7 m/m ² (incl. 10% waste)
Roof tile	~ 14.1 pieces/m ²
Packing unit*	
Tiles per pallet	320 pieces
Tiles per stack	32 pieces
Tiles per pack	8 pieces
Half tile	as required, ~ 3.0 pieces/m
Verge tile	~ 3.0 pieces/m
Walking grid tile	as required
Safety step tile	as required
Ridge or crest tile	~ 2.7 pieces/m
Copper roll/Alu roll 2000 (5 m per roll)	as required
Ridge/crest clip 470/121	1.0 piece per ridge tile
Wood screws	1.0 piece per ridge tile d = 4.5 mm Screw depth: 24 mm
Ridge or crest initial tile	1.0 piece per ridge or crest start
Ridge end tile	1.0 piece per ridge end
Ridge lath holder	1.0 piece per rafter
Crest lath holder	1.0 piece/ ~ 70 cm
Eaves fresh air element	~ 1.1 piece/m Fresh air ~ 200 cm ² /m

* only applies for deliveries in Germany

Laying!

The following applies when laying our clay roof tiles:

1. The NELSKAMP manufacturer's instructions take priority (laying instructions)
2. The specialist rules of the roofing trade (rules for coverings with clay roof tiles)
3. The German Construction Contract Procedures (VOB) (clay roof tile cover)

Regular roof pitch for clay roof tiles

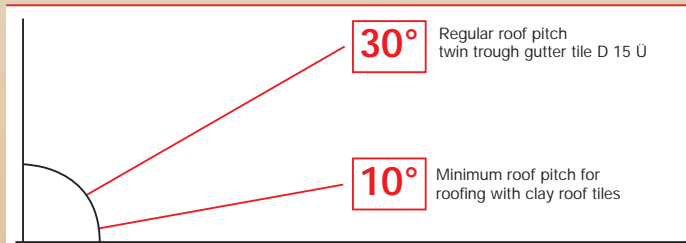

If the pitch is below the regular roof pitch the additional measures of the roofing trade rules must be carried out (cf. table).

With equivalent roof substructure alternatives: pay attention to the manufacturer's and laying instructions. Warranty must be assumed by the relevant manufacturer.

Classification of additional measures except for subordinate buildings ¹⁾ according to the technical rules of the German roofing trade, last revised January 2010

Roof pitch	Higher requirements ²⁾			
	Use - Design - Climatic conditions			
	no further increased requirement ²⁾	one further increased requirement ²⁾	two further increased requirement ²⁾	three further increased requirement ²⁾
≥ 30°	Class 6 3.3 Underlayment (USB- A) ⁴⁾	Class 6 3.3 Underlayment (USB- A) ⁴⁾	Class 5 2.4 Overlapping / interlocking undercover (UDB- A; UDB- B ⁵⁾ ; USB- A) ⁴⁾	Class 4 2.2 Welded / bonded undercover 2.3 Undercover covered with bitumen sheeting 3.2 Underlayment secured at seams (UDB- A; UDB- B ⁵⁾ ; USB- A) ⁴⁾
≥ 26°	Class 4 2.2 Welded / bonded undercover 2.3 Undercover covered with bitumen sheeting 3.2 Underlayment secured at seams (UDB- A; UDB- B ⁵⁾ ; USB- A) ⁴⁾	Class 4 2.2 Welded / bonded undercover 2.3 Undercover covered with bitumen sheeting 3.2 Underlayment secured at seams (UDB- A; UDB- B ⁵⁾ ; USB- A) ⁴⁾	Class 3 2.1 Undercover secured at seams and perforations 3.1 Underlayment secured at seams and perforations (UDB- A; UDB- B ⁵⁾ ; USB- A) ⁴⁾	Class 3 2.1 Undercover secured at seams and perforations 3.1 Underlayment secured at seams and perforations (UDB- A; UDB- B ⁵⁾ ; USB- A) ⁴⁾
≥ 22°	Class 3 2.1 Undercover secured at seams and perforations 3.1 Underlayment secured at seams and perforations (UDB- A; UDB- B ⁵⁾ ; USB- A) ⁴⁾	Class 3 2.1 Undercover secured at seams and perforations 3.1 Underlayment secured at seams and perforations (UDB- A; UDB- B ⁵⁾ ; USB- A) ⁴⁾	Class 3 2.1 Undercover secured at seams and perforations 3.1 Underlayment secured at seams and perforations (UDB- A; UDB- B ⁵⁾ ; USB- A) ⁴⁾	Class 3 ³⁾ 2.1 Undercover secured at seams and perforations 3.1 Underlayment secured at seams and perforations (UDB- A; UDB- B ⁵⁾ ; USB- A) ⁴⁾
≥ 18°	Class 2 1.2 Rainproof roof substructure	Class 2 1.2 Rainproof roof substructure	Class 1 1.1 Waterproof roof substructure	Class 1 1.1 Waterproof roof substructure
≥ 10°	Class 1 1.1 Waterproof roof substructure	Class 1 1.1 Waterproof roof substructure	Class 1 1.1 Waterproof roof substructure	Class 1 1.1 Waterproof roof substructure
MRP	10°			

¹⁾ The additional measures named in the table are minimum measures taking into account table 1 of the "Leaflet for roof substructures, undercovers, underlays".

²⁾ Higher requirements form categories in accordance with Section 1.1.3. Further higher requirements may result from the weighting within a category according to Section 1.1.3. For example, climatic conditions can lead to several higher requirements.

³⁾ Only allowed if proof has been rendered of the functional reliability of the products used including accessories (sealing tapes, adhesive tapes, sealing compounds, ready-made seam protection, etc.) by the manufacturer during a driving rain test. The next highest class should otherwise be chosen.

⁴⁾ Undercover plates are to be assigned according to the classification in the "Leaflet for roof substructures, undercovers and underlays".

⁵⁾ If indices 2), 3), 4), 5) in the product data sheet are met:

2) Resistance to driving rain, proven by the "Driving rain test underlay and undercover sheets - TU Berlin"

3) Higher requirements on ageing are proven by increasing the temperature in the test method Appendix C 5.2 of DIN EN 13859- 1 to 80 °C.

4) The manufacturer specifies the duration of the outdoor weathering period whilst warranting the aforementioned properties.

5) The manufacturer confirms the suitability as a provisional cover and specifies the duration of the outdoor weathering period whilst warranting the aforementioned properties.

Covering widths

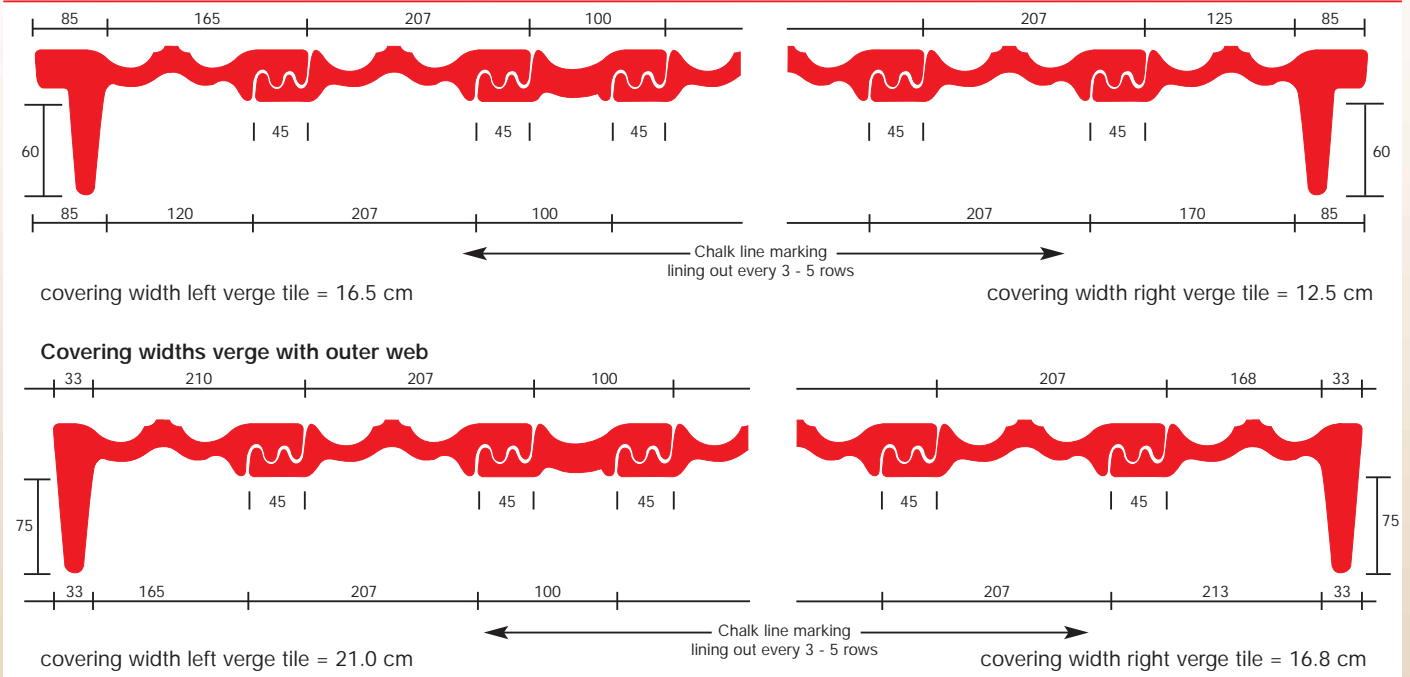

Roof lathing in conjunction with ridge flaps (dry ridge)

Supporting laths:

The following min. cross-sections must be used:
(rules for roofing, notes on wood and timber materials)

Nom. cross-sections of support laths	Rafter intervals (unit spacing)	Sizing class
30 x 50 mm	≤ 80 cm	S 10
40 x 60 mm	≤ 100 cm	S 10

Counter-laths:

Rec. thickness of counter-laths acc. to rules for roofing
(notes on wood and timber materials):

Rafter length	Rec. thickness
up to 8 m	24 mm
up to 12 m	30 mm
over 12 m	40 mm

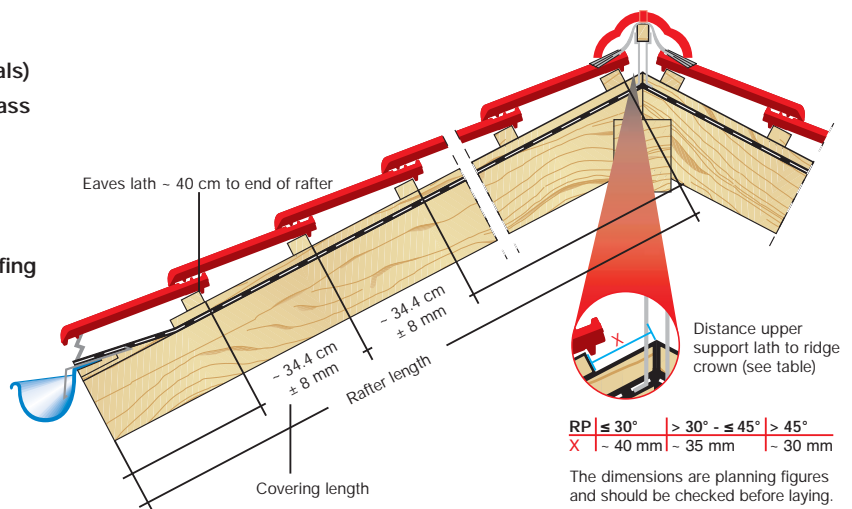

Details eaves design

The dimensions are planning figures and should be checked before laying depending on the design and local circumstances.

1 With gutter & vent element

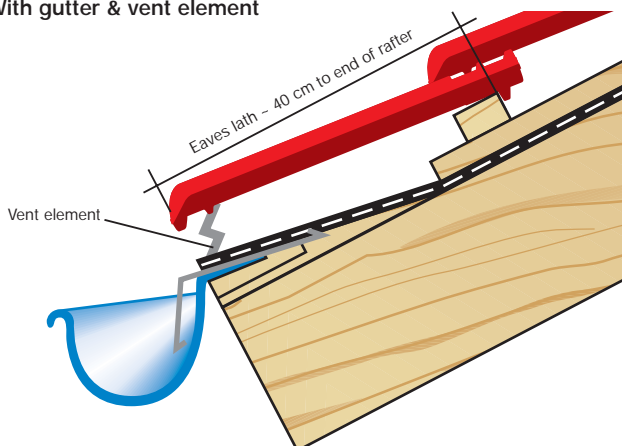

2 High-level gutter (recommended for flat roof pitches < 22°)

Tile overhang in gutter
max. 1/3 of gutter width

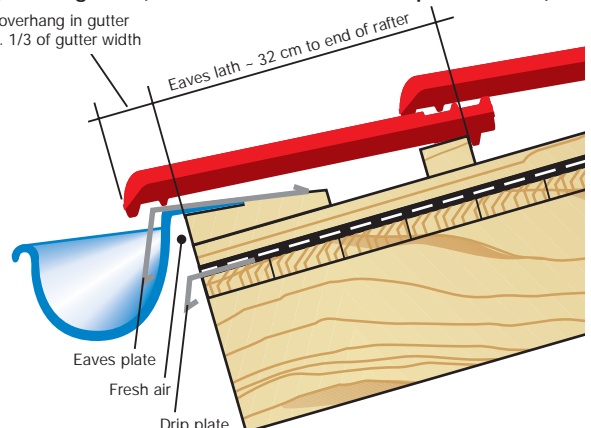

Ridge/crest details

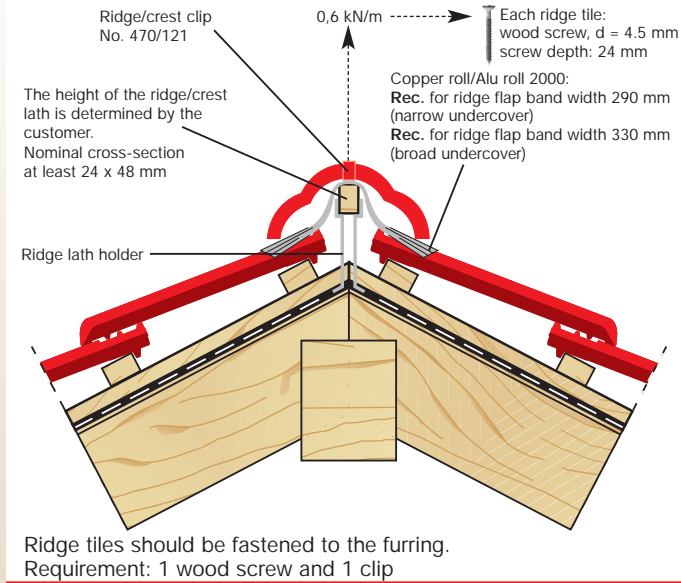

Verge details

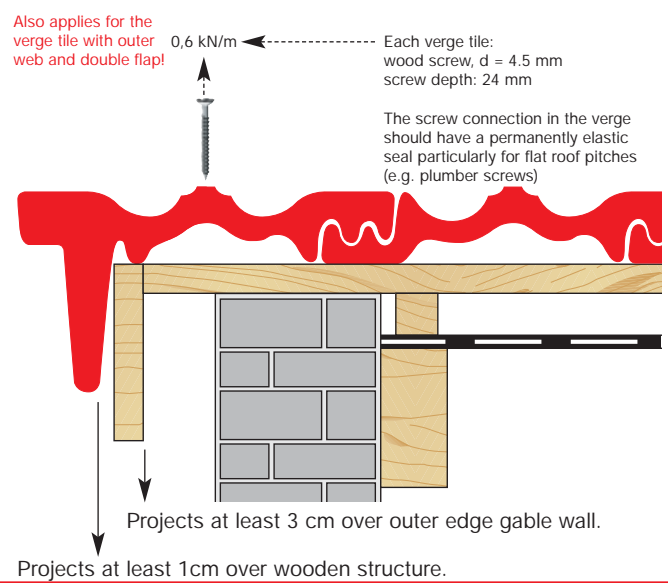

Aeration and ventilation in steep roof

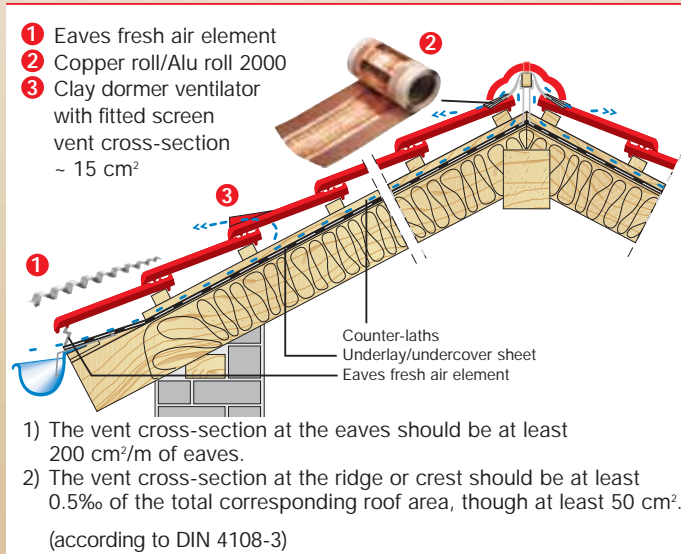

Shed roof tile

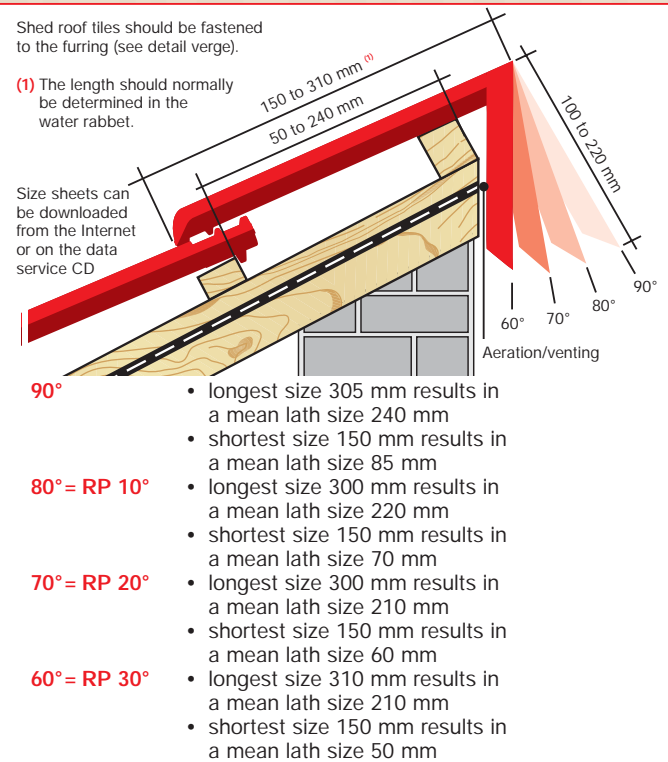

Storm clips

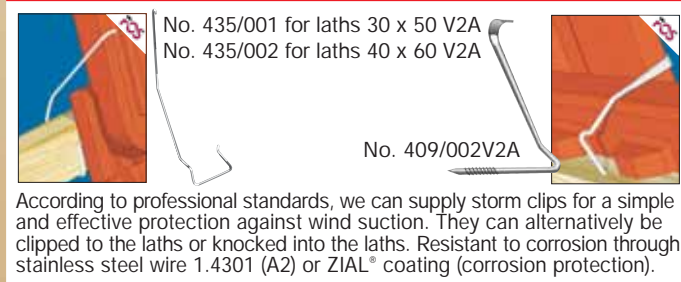

Installation instructions for safety step tile/walking grid tile/snow stop tile

Every safety step tile/walking grid tile must be provided with an additional supporting-safety lath (same lath cross-section as supporting laths). **Fastening to supporting lath:** two corrosion-proof wood screws (4.5 x 45 mm per tile)

Article	≤ 45°	> 45°
Walking grid tile	every 2 nd row of tiles	every row of tiles
Safety step tile	every row of tiles	every row of tiles

tested to DIN EN 516

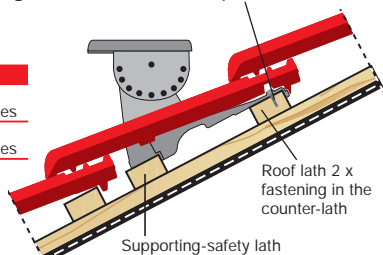

The same applies for interlocking tiles with snow rib or round wood holder, whereby the max. support spacing should not exceed 90 cm. For higher demands you should reduce the support spacing (60 cm).

Installation instructions for universal alu step

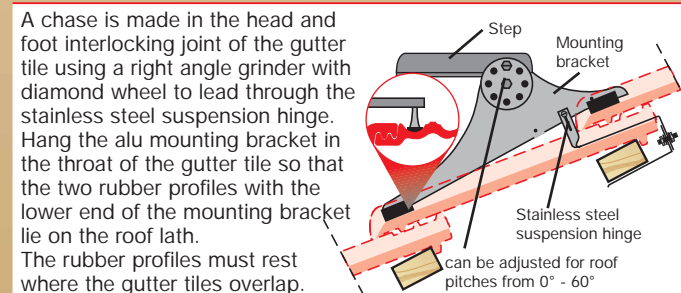

Installation instructions on delivery

tested to DIN EN 516

On the NELSKAMP data service CD or as a download on the Internet from www.nelskamp.de

- Product specifications
- Laying instructions
- CAD data



For colourful, clean roofs. The Nelskamp concrete roofing tile program.

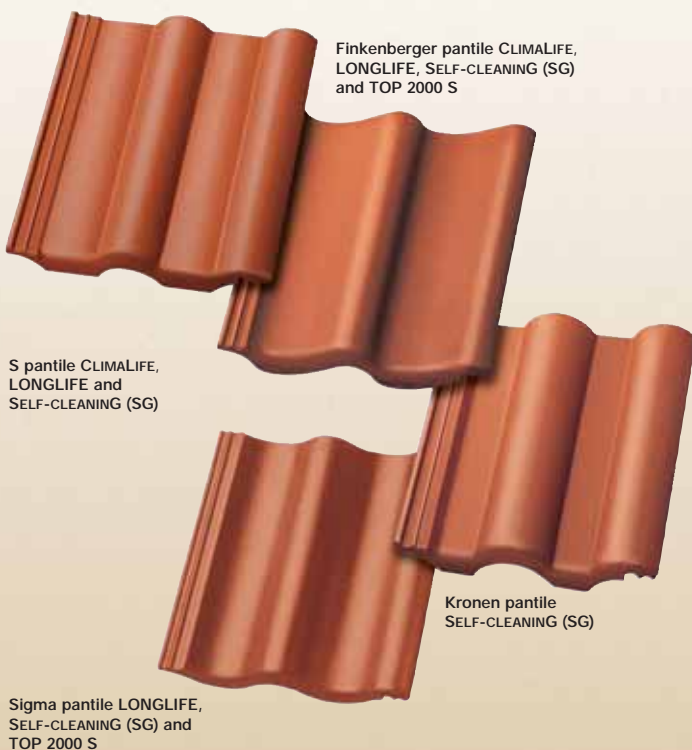

CLIMALIFE concrete roofing tiles

With their ClimaLife surface our roof pantiles clean our environment from contaminants resulting from heating, traffic and the industry. Up to 90 percent are neutralized in daylight, without sunlight up to 70 percent. This is due to the titanium oxide content in the micro concrete. It mainly converts nitrogen oxides (NO_x) into harmless substances like NO₃⁻. Again and again, because titanium oxide is a catalyst, which is never used up. The rain does the rest: It just flushes away the substances, which then are harmless.

LONGLIFE concrete roofing tiles

The leading technology of LONGLIFE concrete roofing tiles is based on the smooth surface of micro-concrete and a newly developed, silk-gloss colour coating. Both factors ensure clean roofs with long-lasting, intensive colours. The reason: dirt is washed off by rain and moss or algae find almost no base for growth.

SELF-CLEANING (SG) concrete roofing tiles

SG = Self-cleaninG concrete roofing tiles are also supplied with the newly developed colour coating. Moss and algae find almost no base for growth on the surface.

TOP 2000 S concrete roofing tiles

High-quality raw materials, the latest production methods and established coating technologies with numerous standard and special colours are characteristic of TOP 2000 S concrete roofing tiles.



Concrete roofing tiles and clay roof tiles from Nelskamp. The obvious solution.

Our strategically placed production facilities guarantee that our roof building materials are always well received. Six plants throughout Germany are the sound, logistical basis for co-operation and help spare the environment.

Administration and sales

Waldweg 6 · D-46514 Schermbeck
Postfach 11 20 · D-46510 Schermbeck
Phone: +49 28 53/91 30-0
Fax: +49 28 53/37 59
Email: vertrieb@nelskamp.de
Internet: www.nelskamp.de

Production of concrete roofing tiles

Gartrop Works
Gahlener Straße 158
D-46569 Hünxe-Gartrop
Phone: +49 28 53/91 30-31/32
Fax: +49 28 53/45 59

Dieburg Works
Lagerstraße 30
D-64807 Dieburg
Phone: +49 60 71/98 64-0
Fax: +49 60 71/16 73

Schönerlinde Works
Schönerlinder Bahnhofstraße 6
D-16348 Wandlitz
Phone: +49 30/94 03 91-0
Fax: +49 30/94 12 20 4

Production of clay roof tiles

Schermbeck Works
Waldweg 6
D-46514 Schermbeck
Phone: +49 28 53/91 30-23/17
Fax: +49 28 53/26 70

Unsleben Works
Wechterswinkler Straße 23
D-97618 Unsleben
Phone: +49 97 73/9 10 10
Fax: +49 97 73/7 49

Groß-Ammensleben Works
Magdeburger Straße 42
D-39326 Groß-Ammensleben
Phone: +49 3 92 02/88-6
Fax: +49 3 92 02/88 80 2

From clay. From concrete. From experience.

NELSKAMP